

Actuator

45-
2131.1110.000



<https://eao.com/p/45-2131.1110.000>

Your product:



45-2131.1110.000 Actuator

FRONT

Front dimension:	Ø 29,5 mm
Front form:	round
Front bezel colour:	Black
Front bezel material:	Plastic

MOUNTING

Design:	raised
Mounting cut-out:	Ø 22.3 mm
Mounting type:	Panel mounting

OPERATING-/INDICATION PART

Lens colour:	Black
Lens material:	Plastic
Lens illumination:	non illuminative
Lens shape:	flush
Lens optics:	opaque

MECHANICAL CHARACTERISTIC

Switching action:	Momentary
Switching system:	Slow-make switching element
Mechanical lifetime:	500 000 cycles of operation
Operating frequency:	Max. 3 600/h

Weight: 0.019 kg

AMBIENT CONDITION

IP front protection: IP66, IP67, IP69K

Operating temperature: – 25 °C ... + 70 °C

Storage temperature: – 40 °C ... + 80 °C

Shock resistance: According to IEC 60068-2-27: Sinusoidal half-wave 50 g / 11 ms

Vibration resistance: According to IEC 60068-2-6: 20 ... 500 Hz: 5 g

Climate resistance: During operation according to IEC 60721: 3K6, 3C3, 3S2, 3M6

CERTIFICATE

REACH: REACH compliant

RoHS: RoHS compliant

OTHER

Short Description: Actuator, Ø 22.3 mm, Ø 29,5 mm, flush, non illuminative, Black, Plastic, opaque, round, Black, Plastic, Momentary, IP66, IP67, IP69K

Housing colour: Black

Housing material: Plastic

Wiring diagrams:

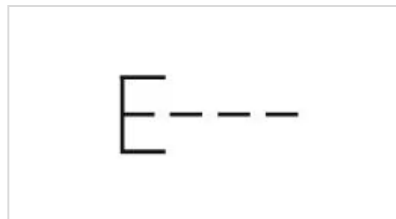



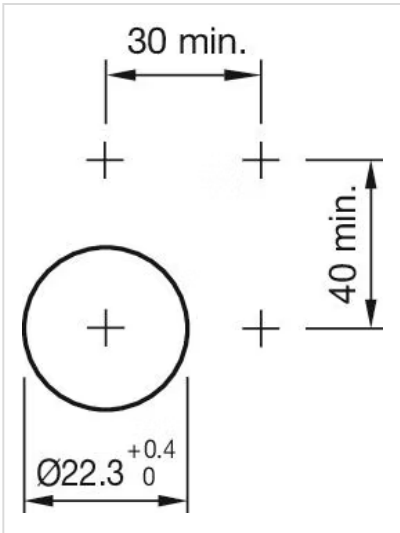



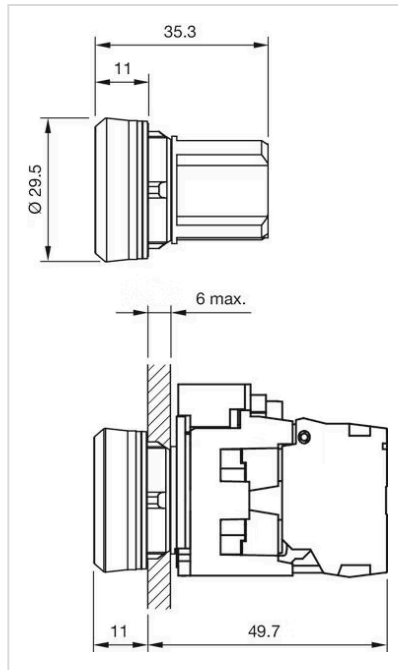



Mounting cut-outs:



Dimension drawings:



Where to Buy

	Distributor	Quantity in Stock	
	element14 Singapore	75 in stock	Buy 
	Farnell UK	75 in stock	Buy 
	RS UK	38 in stock	Buy 
	Distrelec	20 in stock	Buy 
	DigiKey	8 in stock	Buy 

[Show more](#) 

Powered by oemsecrets.com