

Actuator

45-
2231.4FH0.000



<https://eao.com/p/45-2231.4FH0.000>

Your product:



45-2231.4FH0.000 Actuator

FRONT

Front dimension:	Ø 38 mm
Front form:	round
Front bezel colour:	Sand grey
Front bezel material:	Metal

MOUNTING

Design:	flush
Mounting cut-out:	Ø 30.5 mm
Mounting type:	Panel mounting

OPERATING-/INDICATION PART

Lens colour:	Green
Lens material:	Plastic
Lens illumination:	illuminative
Lens shape:	flush
Lens optics:	transparent
Illumination colour:	Green

MECHANICAL CHARACTERISTIC

Switching action:	Momentary
Switching system:	Slow-make switching element
Mechanical lifetime:	3 Mio. cycles of operation

Operating frequency: Max. 3 600/h

Weight: 0.074 kg

AMBIENT CONDITION

IP front protection: IP66, IP67, IP69K

Operating temperature: - 25 °C ... + 70 °C

Storage temperature: - 40 °C ... + 80 °C

Shock resistance: According to IEC 60068-2-27: Sinusoidal half-wave 50 g / 11 ms

Vibration resistance: According to IEC 60068-2-6: 20 ... 500 Hz: 5 g

Climate resistance: During operation according to IEC 60721: 3K6, 3C3, 3S2, 3M6

CERTIFICATE

REACH: REACH compliant

RoHS: RoHS compliant

OTHER

Short Description: Actuator, Ø 30.5 mm, Ø 38 mm, flush, illuminative, Green, Plastic, transparent, round, Sand grey, Metal, Momentary, IP66, IP67, IP69K, Green

Housing colour: Silver

Housing material: Metal

Hints: Front panel thickness 1 ... 6 mm



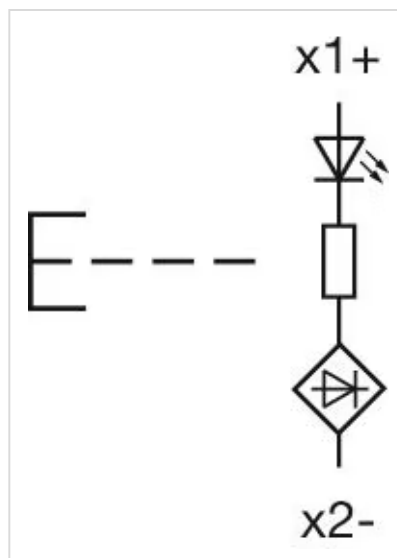



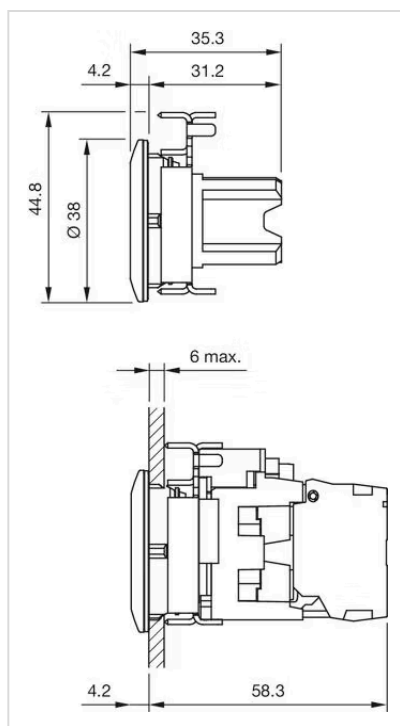



Wiring diagrams:



Dimension drawings:



Where to Buy

	Distributor	Quantity in Stock	
	RS UK	23 in stock	Buy 
	DigiKey	19 in stock	Buy 
	Farnell UK	11 in stock	Buy 
	element14 Singapore	11 in stock	Buy 
	Distrelec	7 in stock	Buy 

[Show more](#) 

Powered by oemsecrets.com