

Actuator

45-
2D36.1820.000



[https://www.eao.com/component/45-
2D36.1820.00...](https://www.eao.com/component/45-2D36.1820.00...)

Your product:



45-2D36.1820.000 Actuator

FRONT

Front dimension:	Ø 34 mm
Front form:	Round
Front bezel colour:	Black
Front bezel material:	Plastic

MOUNTING

Mounting type:	Panel mounting
-----------------------	----------------

OPERATING-/INDICATION PART

Lens colour:	Red
Lens material:	Plastic
Lens illumination:	Illuminated
Lens shape:	Mushroom-head
Lens optics:	opaque

MECHANICAL CHARACTERISTICS

Switching action:	Maintained
Release type:	Twist to unlock
Mechanical lifetime:	300 000 cycles of operation
Operating frequency:	Max. 600/h
Weight:	0.042 kg

AMBIENT CONDITION

Operating temperature:	- 25 °C ... + 70 °C
Storage temperature:	- 40 °C ... + 80 °C
Shock resistance:	According to IEC 60068-2-27: Sinusoidal half-wave 50 g / 11 ms
Vibration resistance:	According to IEC 60068-2-6: 2 ... 500 Hz: 5 g
Climate resistance:	During operation according to IEC 60721: 3K6, 3C3, 3S2, 3M6

CERTIFICATE

REACH:	REACH compliant
RoHS:	RoHS compliant

OTHER

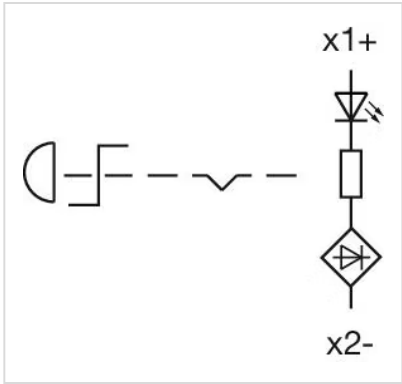
Short Description:	Actuator, Ø 34 mm, Mushroom-head, Illuminated, Red, Plastic, opaque, Round, Black, Plastic, Maintained, Twist to unlock
Dimension:	Ø 34 mm
Housing colour:	Yellow
Housing material:	Plastic
Product attributes:	Twist to unlock anti-clockwise
Hints:	Application as per DIN EN ISO 13850 and EN 60204-1
Wiring diagrams:	

Mounting cut-outs:



Dimension drawings:

