

# Actuator

45-  
2D36.2820.000



<https://www.eao.com/component/45-2D36.2820.00...>

Your product:

---



## 45-2D36.2820.000 Actuator

### FRONT

<b>Front dimension:</b>	Ø 34 mm
<b>Front form:</b>	Round
<b>Front bezel colour:</b>	Silver
<b>Front bezel material:</b>	Metal

### MOUNTING

<b>Mounting type:</b>	Panel mounting
-----------------------	----------------

### OPERATING-/INDICATION PART

<b>Lens colour:</b>	Red
<b>Lens material:</b>	Plastic
<b>Lens illumination:</b>	Illuminated
<b>Lens shape:</b>	Mushroom-head
<b>Lens optics:</b>	opaque

### MECHANICAL CHARACTERISTICS

<b>Switching action:</b>	Maintained
<b>Release type:</b>	Twist to unlock
<b>Mechanical lifetime:</b>	300 000 cycles of operation
<b>Operating frequency:</b>	Max. 600/h
<b>Weight:</b>	0.088 kg

## AMBIENT CONDITION

<b>Operating temperature:</b>	- 25 °C ... + 70 °C
<b>Storage temperature:</b>	- 40 °C ... + 80 °C
<b>Shock resistance:</b>	According to IEC 60068-2-27: Sinusoidal half-wave 50 g / 11 ms
<b>Vibration resistance:</b>	According to IEC 60068-2-6: 2 ... 500 Hz: 5 g
<b>Climate resistance:</b>	During operation according to IEC 60721: 3K6, 3C3, 3S2, 3M6

## CERTIFICATE

<b>REACH:</b>	REACH compliant
<b>RoHS:</b>	RoHS compliant

## OTHER

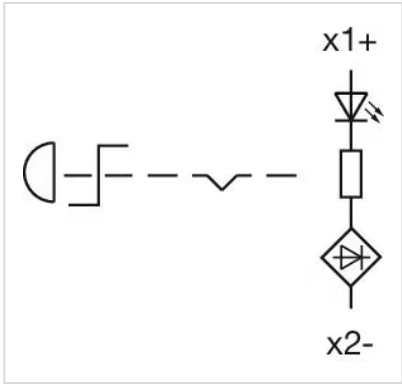
<b>Short Description:</b>	Actuator, Ø 34 mm, Mushroom-head, Illuminated, Red, Plastic, opaque, Round, Silver, Metal, Maintained, Twist to unlock
<b>Dimension:</b>	Ø 34 mm
<b>Housing colour:</b>	Silver
<b>Housing material:</b>	Metal
<b>Product attributes:</b>	Twist to unlock clockwise
<b>Hints:</b>	Application as per DIN EN ISO 13850 and EN 60204-1
<b>Wiring diagrams:</b>	

**Mounting cut-outs:**



**Dimension drawings:**

