

Illumination element

45-320.1E41

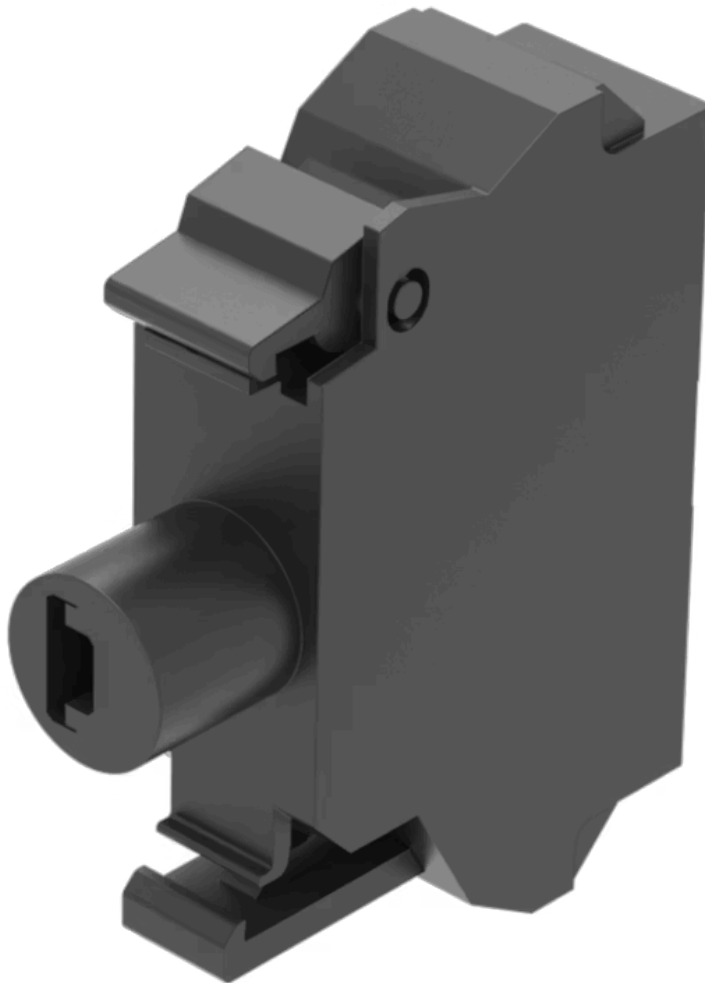

<https://www.eao.com/component/45-320.1E41/en/...>

Your product:



45-320.1E41 Illumination element

MOUNTING

Component mounting type: Front mounting

OPERATING-/INDICATION PART

Illumination colour: Red

ELECTRICAL CHARACTERISTICS

Operating voltage: 6 - 24 V AC/DC

Surge voltage resistance: 4 kV

Lumi. Intensity: 450 - 1120 mcd

MECHANICAL CHARACTERISTICS

Terminal: Spring-type terminal

Terminal details 1:
Solid 2 x (0.25 ... 1.5mm²)
Finely stranded
– Without end sleeves 2 x (0.5 ... 1.5 mm²)
– With end sleeves 2 x (0.5 ... 0.75 mm²)
– For AWG cables for auxiliary contacts 2 x (24 ... 16)

Weight: 0.008 kg

CERTIFICATE

REACH: REACH compliant

RoHS: RoHS compliant

OTHER

Short Description:

Illumination element, Spring-type terminal, Red, 6 - 24 V AC/DC, Front mounting

Wiring diagrams:

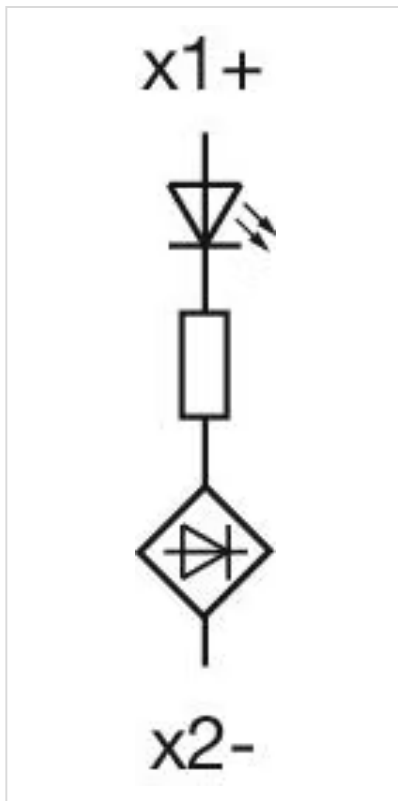

Dimension drawings:

