

Actuator

45-
482.1810

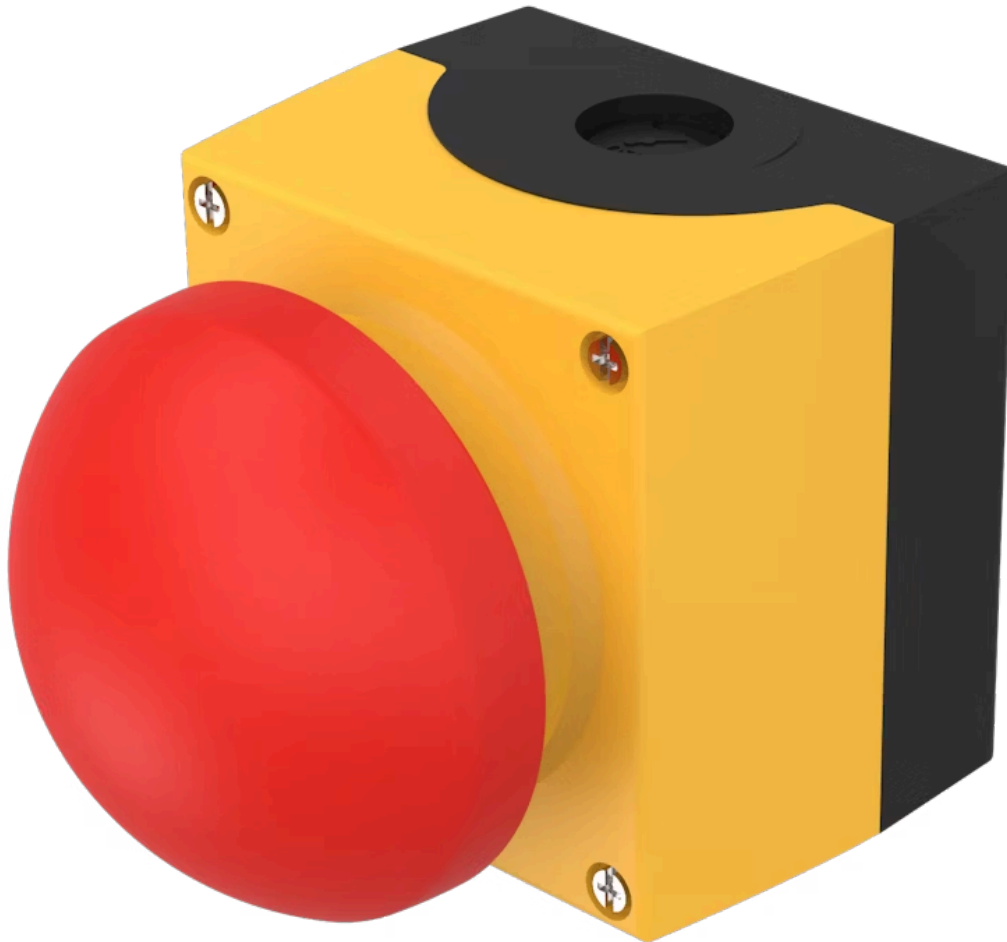

<https://eao.com/p/45-482.1810>

Your product:



45-482.1810 Actuator

FRONT

Front dimension: 85 mm x 85 mm

Front form: square

MOUNTING

Design: raised

Mounting cut-out: Ø 22.3 mm

Component mounting type: Base mounting

Mounting type: Panel mounting

OPERATING-/INDICATION PART

Lens colour: Red

Lens material: Plastic

Lens illumination: non illuminative

Lens optics: opaque

ELECTRICAL CHARACTERISTICS

Rated Operational Voltage U_e: At AC: rated value 5 ... 500 V
At DC: rated value 5 ... 500 V

MECHANICAL CHARACTERISTIC

Switching action: Maintained

Switching system: Slow-make switching element

Release type: Pull unlock

Weight: 0.39 kg

AMBIENT CONDITION

IP front protection: IP66, IP67, IP69K

Storage temperature: - 40 °C ... + 80 °C

Shock resistance: According to IEC 60068-2-27: Sinusoidal half-wave 50 g / 11 ms

Vibration resistance: According to IEC 60068-2-6: 10 ... 500 Hz: 5 g

Climate resistance: During operation according to IEC 60721: 3K6, 3C3, 3S2, 3M6, 3B2

CERTIFICATE

REACH: REACH compliant

RoHS: RoHS compliant

OTHER

Short Description: Actuator, Ø 22.3 mm, 85 mm x 85 mm, non illuminative, Red, Plastic, opaque, square, Maintained, IP66, IP67, IP69K, Pull unlock







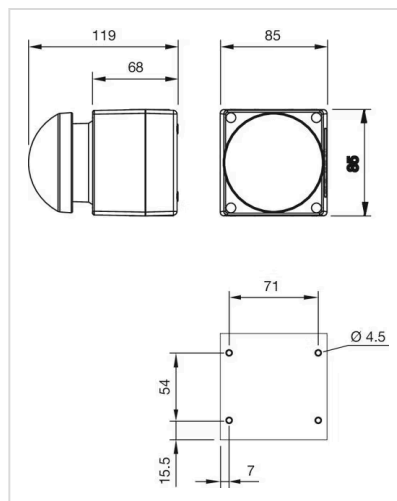



Housing colour: Yellow

Housing material: Plastic

Dimension drawings:



Where to Buy

	Distributor	Quantity in Stock	
	DigiKey	9 in stock	Buy 
	Distrelec	4 in stock	Buy 
	element14 Singapore	3 in stock	Buy 
	Farnell UK	3 in stock	Buy 
	Mouser Electronics	2 in stock	Buy 

[Show more](#) 

Powered by oemsecrets.com