

# Actuator

52-  
133.0252



<https://www.eao.com/component/52-133.0252/en/...>

Your product:

---



## 52-133.0252 Actuator

### MOUNTING

**Mounting type:** Panel mounting

### OPERATING-/INDICATION PART

**Lever material:** plastic

**Lever shape:** short

### ELECTRICAL CHARACTERISTICS

**Switching voltage and switching current:**  
250 VAC, 5 A (ohmic)  
250 VAC, 3 A (Soldering terminal)  
250 VAC, 2 A (inductive,  $\cos(\phi) = 0.7$ )  
125 VAC, 3 A (inductive,  $\cos(\phi) = 0.7$ )  
220 VDC, 0.1 A (inductive, L:R = 30 ms)  
110 VDC, 0.2 A (inductive, L:R = 30 ms)  
60 VDC, 0.7 A (inductive, L:R = 30 ms)  
24 VDC, 2 A (inductive, L:R = 30 ms)

**Contacts:** 3 NC / 3 NO

**Rated Operational Voltage  $U_e$ :** 250 VAC/DC according to EN IEC 60947-1

**Switching rating:** 250 V @ 5 A

**Electrical lifetime:** 50 000 cycles of operation

**Electric strength:** 2500 VAC, 50 Hz, 1 min. between all terminals and earth, according to IEC 61058-1, part 15

**Protection class:** II

**Standards:** According to EN/IEC 61058-1

**Thermal current  $I_{th}$ :** 5 A, according to EN / IEC 60947-5-1  
The maximum current in continuous operation and at ambient temperature not exceeding the quoted maximum values.

### MECHANICAL CHARACTERISTICS

<b>Terminal:</b>	Soldering terminal
<b>Contact material:</b>	Gold
<b>Switching action:</b>	Rest - Momentary
<b>Switching system:</b>	Snap-action switching element
<b>Switching system:</b>	Self-cleaning, double-break snap action switching system, 1 normally closed and 1 normally open contact per element.
<b>Switching positions:</b>	2 positions
<b>Switching angle:</b>	42° right
<b>Mechanical lifetime:</b>	2 Mil. cycles of operation
<b>Operating force:</b>	1,8 ... 6 N, depending on the number of switching elements
<b>Tightening torque:</b>	Fixing nut max. 0.5 Nm
<b>Wire cross section:</b>	Snap-action switching element with tinned soldering terminals at the sides Max. wire diameter 2 wires à 1.2 mm Max. wire cross-section of stranded cable 1 x 1 mm <sup>2</sup>
<b>Weight:</b>	0.009 kg

#### **AMBIENT CONDITION**

<b>IP front protection:</b>	IP65, according to DIN EN 60529
<b>Operating temperature:</b>	- 25 °C ... + 55 °C
<b>Storage temperature:</b>	- 40 °C ... + 85 °C
<b>Shock resistance:</b>	15 g for 11 ms, as per DIN / EN 60512-4-3, DIN / EN 60068-2-27 (Single impacts, semi-sinusoidal)
<b>Vibration resistance:</b>	10 g at 10 Hz...1500 Hz, amplitude 0.75 mm (Sinusoidal), according to DIN EN 60512-4-4, DIN EN 60068-2-6
<b>Climate resistance:</b>	Standard condition, as per DIN EN 60068-2-30 Changing condition, as per DIN EN 60068-2-14

#### **CERTIFICATE**

<b>Approbations:</b>	CB (IEC 61058-1), CQC, CSA, DNV, ENEC (EN 61058-1), UL
<b>Conformities:</b>	CE, UKCA, 2011 / 65 / EC (RoHS), 2014 / 30 / EU (EMC), 2014 / 35 / EU (LVD)
<b>REACH:</b>	REACH compliant
<b>RoHS:</b>	RoHS compliant

#### **OTHER**

<b>Short Description:</b>	Actuator, optional illuminative, short, 3 NC / 3 NO, Rest - Momentary, Soldering terminal, IP65, according to DIN EN 60529
---------------------------	--

**Housing colour:**

Black

**Hints:**

Illuminative

**Switching positions:**

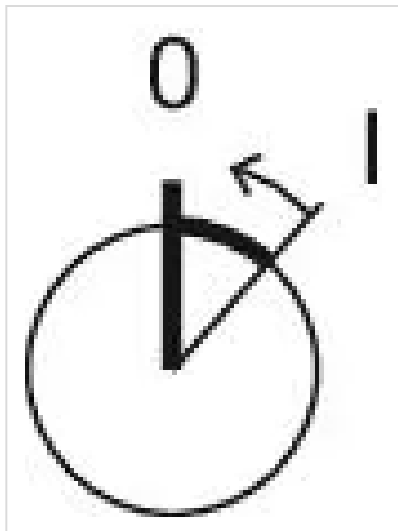

**Wiring diagrams:**

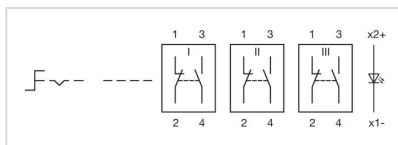

**Mounting cut-outs:**

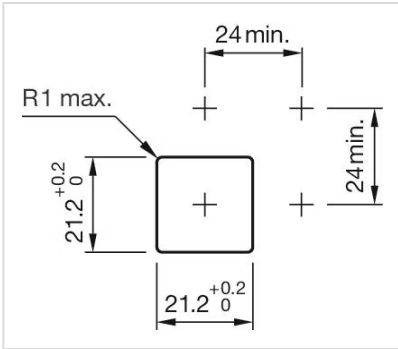
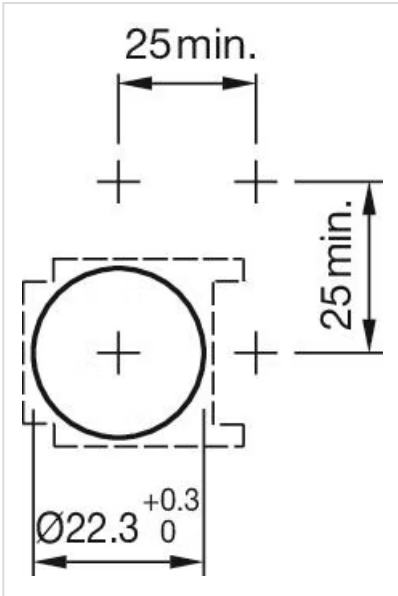
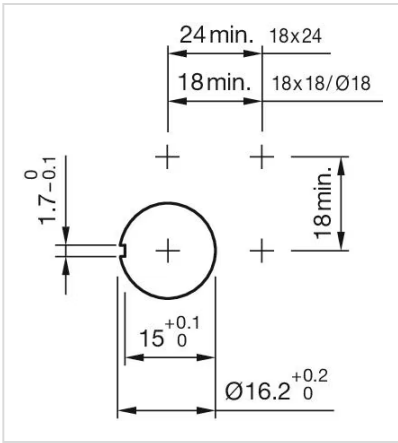

**Dimension drawings:**

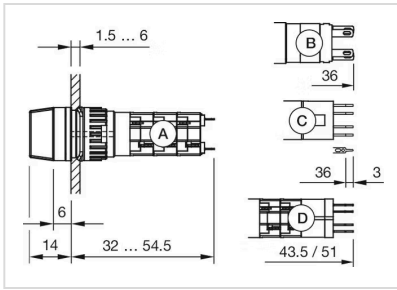

A = Solder terminal  
 B = Plug-in terminal 2.8 mm x 0.5 mm  
 C = Universal terminal 2.0 mm x 0.5 mm  
 D = Universal-Solder terminal

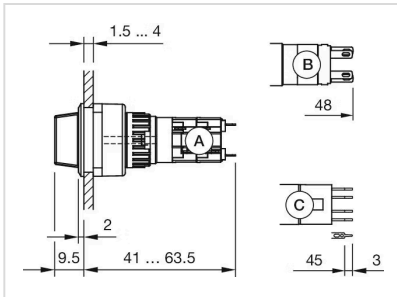

A = Solder terminal  
 B = Solder terminal 2.8 mm x 0.5 mm  
 C = Universal terminal 2.0 mm x 0.5 mm