

Actuator

61-
2601.0/D



<https://www.eao.com/component/61-2601.0/D/en/...>

Your product:



61-2601.0/D Actuator

MOUNTING

Mounting type: Panel mounting

ELECTRICAL CHARACTERISTICS

Electrostatic discharge (ESD): 11 kV

MECHANICAL CHARACTERISTICS

Switching action: Maintained - Rest (a) - Maintained

Switching positions: 3 positions

Switching angle: 90° left / 90° right

Mechanical lifetime: According to DIN/IEC 60512-5-6 and EN/IEC 60947-5-1, 50 000 cycles of operation

Operating force: 0.025...0.1 Nm snap-action switching element, 0.4 ... 0.16 Nm slow-make switching element

Operating Travel: ca. 2 x 90°

Tightening torque: Max. 0.5 Nm

Weight: 0.065 kg

AMBIENT CONDITION

IP Protection: IP40 rear side, according to EN IEC 60529, IP67 front side, according to EN IEC 60529

Operating temperature: - 25 °C ... + 55 °C

Storage temperature: - 40 °C ... + 85 °C

CERTIFICATE

REACH: REACH compliant

RoHS: RoHS compliant

OTHER

Short Description: Actuator, Maintained - Rest (a) - Maintained

Housing material: Plastic, according to UL 94 V0, self-extinguishing

Product attributes: Standard lock: DOM 311

Switching positions:

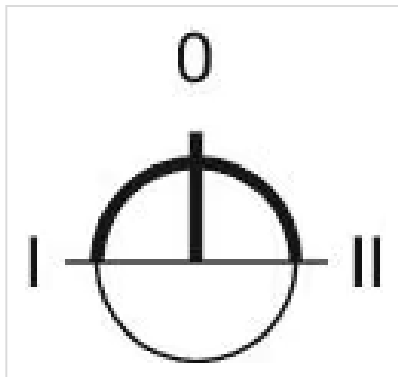

Wiring diagrams:



Mounting cut-outs:

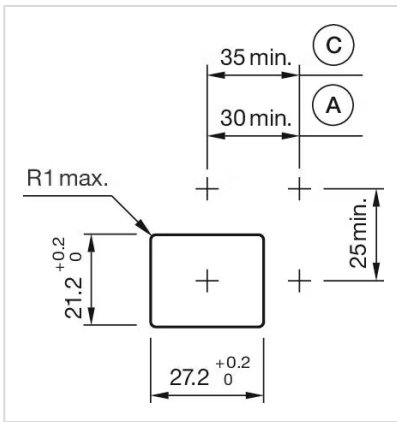

A = Solder/Plug-in terminal 2.8 mm x 0.5 mm
 C = Screw terminal

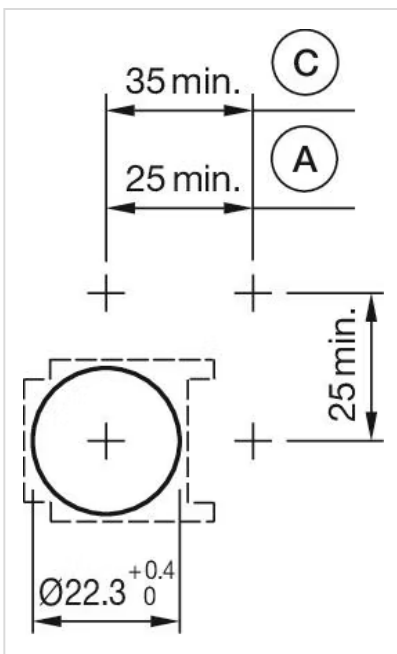

A = Solder/Plug-in terminal 2.8 mm x 0.5 mm
 C = Screw terminal

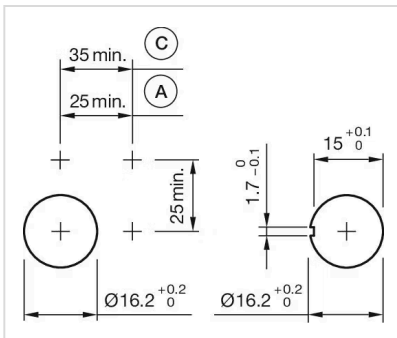

A = Solder/Plug-in terminal 2.8 mm x 0.5 mm
 C = Screw terminal

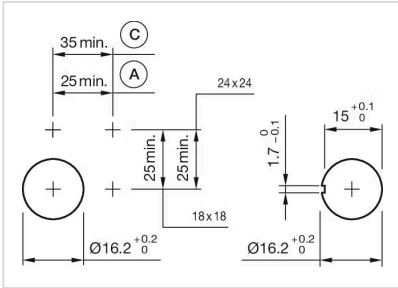

A = Solder/Plug-in terminal 2.8 mm x 0.5 mm
 C = Screw terminal

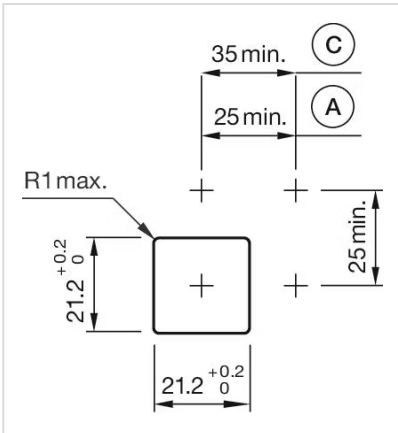

A = Solder/Plug-in terminal 2.8 mm x 0.5 mm
 C = Screw terminal

Dimension drawings:

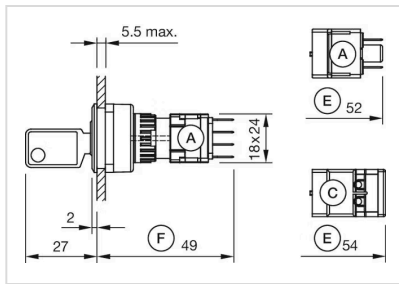

A = Plug-in terminal 2.8 mm x 0.5 mm
 C = Screw terminal
 E = Slow-make switching element
 F = Snap-action switching element

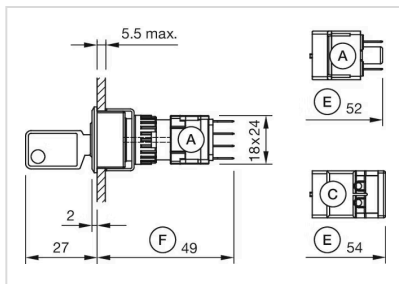

A = Plug-in terminal 2.8 mm x 0.5 mm
 C = Screw terminal
 E = Slow-make switching element
 F = Snap-action switching element

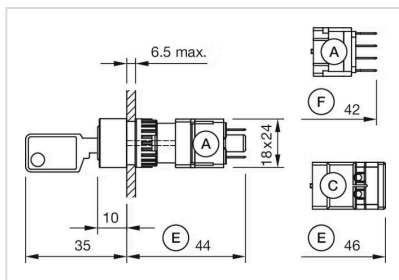

A = Plug-in terminal 2.8 mm x 0.5 mm
 C = Screw terminal
 E = Slow-make switching element
 F = Snap-action switching element