

Capacitive sensor switch with IO-Link Hygiene

84-ACKS-C12-04C1



<https://www.eao.com/component/84-ACKS-C12-04C...>

Your product:



84-ACKS-C12-04C1

Capacitive sensor switch with IO-Link Hygiene

FRONT

Front dimension:	Ø 30 mm
Front form:	Round
Front bezel material:	Stainless steel 316L

MOUNTING

Design:	Flush
Mounting cut-out:	Ø 22.5 mm
Mounting type:	Panel mounting

OPERATING-/INDICATION PART

Lens material:	Plastic
Lens illumination:	Illuminated
Lens shape:	Flush
Lens optics:	transparent
Symbol:	ON/OFF (C12)

ELECTRICAL CHARACTERISTICS

Operating voltage:	8.4 - 32 V DC
Communication interface:	IO-Link specification

MECHANICAL CHARACTERISTICS

Terminal:	Connector M12
------------------	---------------

Switching system: Capacitive
Operating force: No actuating force necessary
Weight: 0.015 kg

AMBIENT CONDITION

IP front protection: IP69K
IK front protection: IK08
Operating temperature: – 30 °C ... + 65 °C
Climate resistance: Relative humidity, max. 95%, non-condensing

CERTIFICATE

Approbations: CSA, EHEDG
Conformities: CE, UKCA
REACH: REACH compliant
RoHS: RoHS compliant

OTHER

Short Description: Capacitive sensor switch with IO-Link Hygiene, Ø 22.5 mm, Ø 30 mm, Flush, Illuminated, Plastic, transparent, Round, Stainless steel 316L, Connector M12, IP69K, IK08, ON/OFF (C12)

Housing colour: Black

Housing material: Plastic

Wiring diagrams:

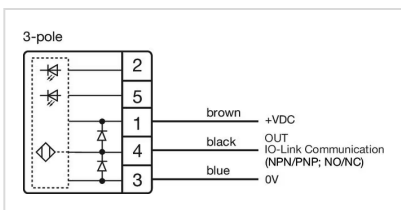
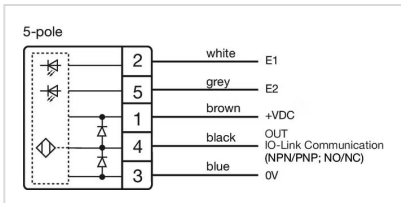

Component layouts:

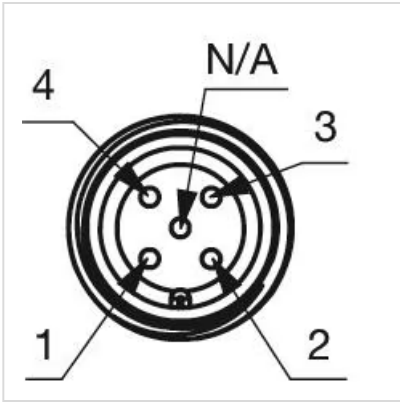

Mounting cut-outs:



Dimension drawings:

