

# IO-Link Touch Standard

84-ASKS-B14-04A0



<https://eao.com/p/84-ASKS-B14-04A0>

Your product:

---



## 84-ASKS-B14-04A0 IO-Link Touch Standard

### FRONT

<b>Front dimension:</b>	Ø 30 mm
<b>Front form:</b>	round
<b>Front bezel material:</b>	Plastic

### MOUNTING

<b>Design:</b>	flush
<b>Mounting cut-out:</b>	Ø 22.5 mm
<b>Mounting type:</b>	Panel mounting

### OPERATING-/INDICATION PART

<b>Lens material:</b>	Plastic
<b>Lens illumination:</b>	illuminative
<b>Lens shape:</b>	flush
<b>Lens optics:</b>	transparent
<b>Symbol:</b>	Standby (B14)

### ELECTRICAL CHARACTERISTICS

<b>Operating voltage:</b>	8,4 - 32 V DC
---------------------------	---------------

### MECHANICAL CHARACTERISTIC

<b>Terminal:</b>	Connector M12
<b>Switching system:</b>	Capacitive

**Operating force:** No actuating force necessary

**Weight:** 0.015 kg

### AMBIENT CONDITION

**IP front protection:** IP69K

**IK front protection:** IK08

**Operating temperature:** - 30 °C ... + 65 °C

**Climate resistance:** Relative humidity, max. 95%, non-condensing

### CERTIFICATE

**Approbations:** CSA, EHEDG

**Conformities:** CE, UKCA

**REACH:** REACH compliant

**RoHS:** RoHS compliant

### OTHER

**Short Description:** IO-Link Touch Standard, Ø 22.5 mm, Ø 30 mm, flush, illuminative, Plastic, transparent, round, Plastic, Connector M12, IP69K, IK08, Standby (B14)

**Housing colour:** Black

**Housing material:** Plastic

**Wiring diagrams:**

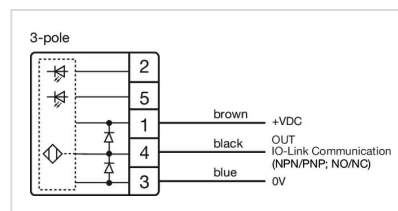
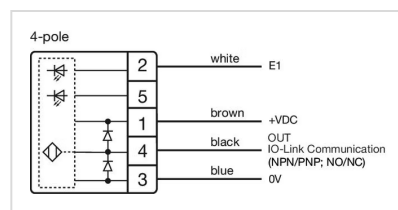
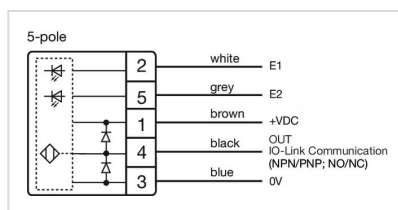

**Component layouts:**

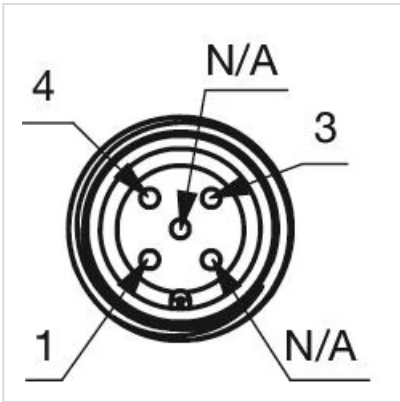
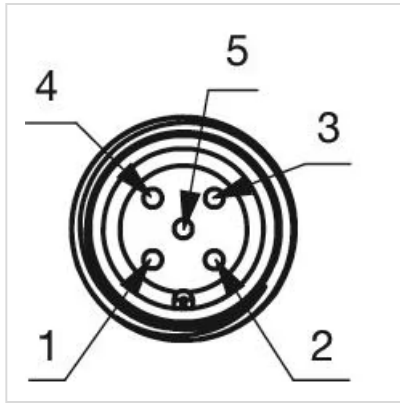
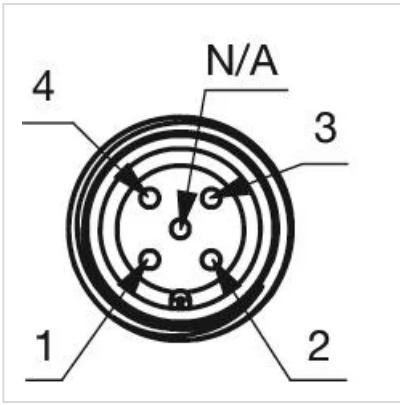

**Mounting cut-outs:**

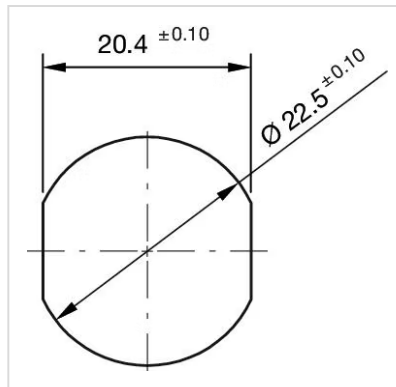

**Dimension drawings:**

