

# Capacitive sensor switch with IO-Link Standard

84-ASKS-B15-04A1



<https://www.eao.com/p/84-ASKS-B15-04A1>

Your product:

---



## 84-ASKS-B15-04A1

### Capacitive sensor switch with IO-Link Standard

#### FRONT

<b>Front dimension:</b>	Ø 30 mm
<b>Front form:</b>	Round
<b>Front bezel material:</b>	Plastic

#### MOUNTING

<b>Design:</b>	Flush
<b>Mounting cut-out:</b>	Ø 22.5 mm
<b>Mounting type:</b>	Panel mounting

#### OPERATING-/INDICATION PART

<b>Lens material:</b>	Plastic
<b>Lens illumination:</b>	Illuminated
<b>Lens shape:</b>	Flush
<b>Lens optics:</b>	transparent
<b>Symbol:</b>	arrows (B15)

#### ELECTRICAL CHARACTERISTICS

<b>Operating voltage:</b>	8.4 - 32 V DC
<b>Switching rating:</b>	
<b>Communication interface:</b>	IO-Link specification

#### MECHANICAL CHARACTERISTIC

**Terminal:** Connector M12

**Switching system:** Capacitive

**Operating force:** No actuating force necessary

**Weight:** 0.015 kg

**AMBIENT CONDITION**

**IP front protection:** IP69K

**IK front protection:** IK08

**Operating temperature:** - 30 °C ... + 65 °C

**Climate resistance:** Relative humidity, max. 95%, non-condensing

**CERTIFICATE**

**Approbations:** CSA, EHEDG

**Conformities:** CE, UKCA

**REACH:** REACH compliant

**RoHS:** RoHS compliant

**OTHER**

**Short Description:** Capacitive sensor switch with IO-Link Standard, Ø 22.5 mm, Ø 30 mm, Flush, Illuminated, Plastic, transparent, Round, Plastic, Connector M12, IP69K, IK08, arrows (B15)

**Housing colour:** Black

**Housing material:** Plastic

**Wiring diagrams:**

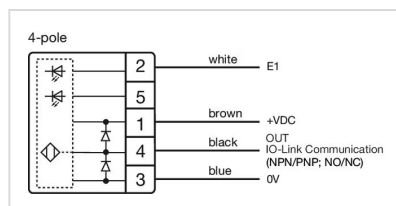
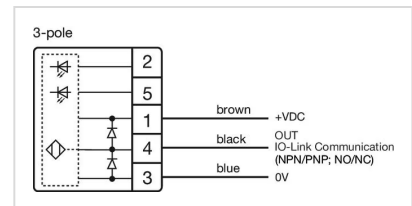
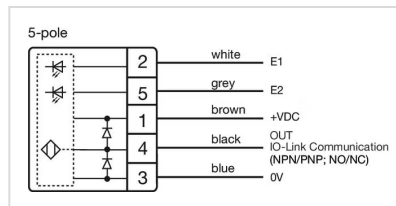

**Component layouts:**

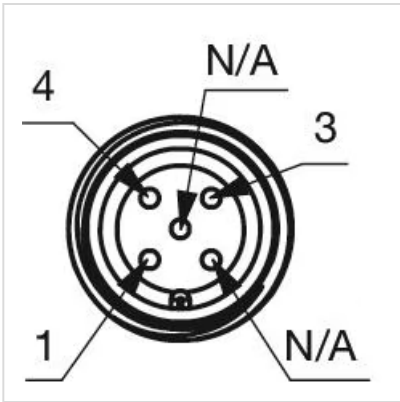
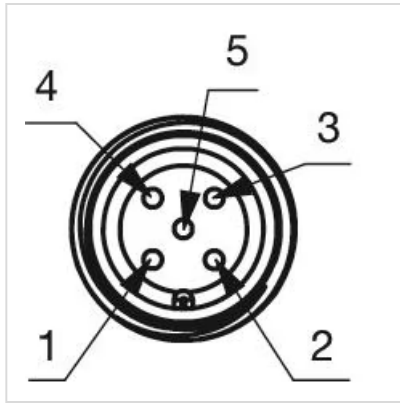
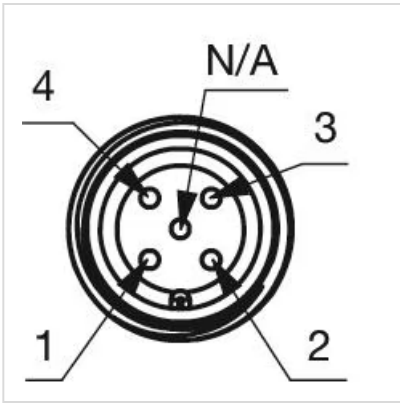

**Mounting cut-outs:**

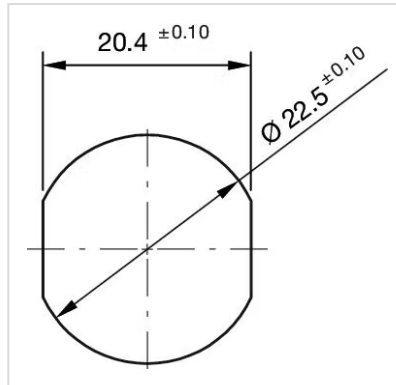

**Dimension drawings:**

